

# Charbro®

## CONTRACTOR®



**BOTTLE MOUNTED GAS RADIANT HEATER**

**MODEL NO: GRH15-BM**

PART NO: 6920025

## OPERATION & MAINTENANCE INSTRUCTIONS



ORIGINAL INSTRUCTIONS

DL0223

---

## INTRODUCTION

---

Thank you for purchasing this CLARKE heater.

This portable gas radiant heater is designed to give safe, efficient and reliable operation and is for use with **Propane Gas only**. Propane gas bottles are readily available from builders merchants or gas suppliers.

The heater intended for drying and the warming of commercial/industrial buildings where adequate ventilation is provided.

- **It must always be operated as prescribed in this manual.**
- **It is not intended for domestic use or for the heating of habitable areas.**
- **It is not intended to be used to reach and maintain a certain level of human thermal comfort within an enclosed space.**
- **It is not intended to be used in enclosed areas with restricted ventilation.**
- **It is not for use in areas with high levels of fluctuating drafts.**
- **It is not intended for warming animals or live stock.**
- **We recommend the use of a carbon monoxide detector.**

As with any equipment, optimum performance will only be achieved if the correct application and servicing procedures are followed.

Proper combustion depends upon correct air flow and the heater must not be modified or operated with parts removed or missing. Likewise, safety systems must not be circumvented or modified in order to operate the heater.

Before attempting to use this product, please read this manual thoroughly and follow the instructions carefully. In doing so you will ensure the safety of yourself and that of others around you and you can look forward to your purchase giving you long and satisfactory service.

---

## GUARANTEE

---

This product is guaranteed against faulty manufacture for a period of 12 months from the date of purchase. Please keep your receipt which will be required as proof of purchase.

This guarantee is invalid if the product is found to have been abused or tampered with in any way, or not used for the purpose for which it was intended.

Faulty goods should be returned to their place of purchase, no product can be returned to us without prior permission. This guarantee does not effect your statutory rights.

---

## GENERAL SAFETY PRECAUTIONS

---

Read and ensure you fully understand the following precautions and the hazards associated with this type of equipment.

1. Check the heater thoroughly for damage. **NEVER** operate a damaged heater.
2. **DO NOT** modify the heater or operate a heater which has been modified.
3. Use only propane gas (LPG).
4. Use only a **VAPOUR WITHDRAWAL** propane supply. If there is any question about vapour withdrawal, ask your propane dealer.
5. Position the propane bottle vertically (shut-off valve up). Secure it from falling or being knocked over and protect from damage.
6. **DO NOT** direct the heater towards the bottle.
7. **IMPORTANT:** Use only the hose and regulator assembly provided with the heater. Inspect the hose assembly before each use of the heater. If there is excessive abrasion or wear, or hose is cut, replace with the hose assembly listed on the parts list (page 14) before using the heater.
8. Position the heater such that it is not directly exposed to water spray, rain and/or dripping water
9. This heater is for indoor use only in well ventilated areas.
10. If at any time, gas odour is detected, **IMMEDIATELY STOP** operation until the source of the gas has been located & rectified
11. **DO NOT** use to heat or cook food.
12. **DO NOT** place the heater near combustible materials such as curtains, furniture etc. Allow at least 1 metre clearance.
13. Due to the high surface temperatures, users must observe sufficient clearance to avoid burns or clothing ignition.
14. Place the bottle on a firm, level surface.
15. **DO NOT** use with ductwork. **DO NOT** restrict air circulation.
16. **DO NOT** move, handle or clean while hot or burning.
17. Use only in accordance with local codes of practice.
18. **DO NOT** apply any torsional stress to the hose.
19. **DO NOT** leave the heater un-attended, for example, left on at night.
20. The heater is designed to heat enclosed areas such as workshops. **DO NOT** use the heater for any other function. It is not suitable for drying clothes or laundry.
21. Young children must be kept away unless continuously supervised.

---

## FRESH AIR REQUIREMENTS

---

- **DO NOT** use in unventilated areas.
- The flow of combustion and ventilation air must not be obstructed.



**WARNING: PROVIDE AT LEAST A 1M<sup>2</sup> OPENING OF FRESH, OUTSIDE AIR WHILST USING THIS HEATER. IF FRESH OUTSIDE AIR VENTILATION IS NOT PROVIDED, CARBON MONOXIDE POISONING CAN OCCUR.**

---

---

## RISKS OF CARBON MONOXIDE POISONING

---

Even though this heater operates very close to 100 percent combustion efficiency, it still produces small amounts of carbon monoxide.

- Carbon Monoxide (CO) is toxic.
- Pregnant women, persons with a heart or lung condition, anaemia or under the influence of alcohol or drugs, or those at high altitude, are more likely to be effected by Carbon Monoxide.
- CO can build up in a confined space and failure to provide adequate ventilation can be fatal.

The early symptoms of carbon monoxide poisoning are:

- headaches
- dizziness
- nausea
- dry mouth or sore throat
- blurred vision
- shortness of breath
- confusion
- loss of consciousness

Should anyone show these symptoms they must **GET FRESH AIR IMMEDIATELY**. Turn off the heater and have it serviced before using it again.

Be sure to follow all warnings in this manual.

**WE RECOMMEND THE USE OF A CARBON MONOXIDE DETECTOR**

---

## IF YOU SMELL GAS

---

Liquid Propane gas has a man-made odourant added specifically for detection of gas leaks.

If a leak occurs you should be able to smell the gas. Since Propane (LP) is heavier than air you should smell for the gas odour near to the floor. **ANY GAS ODOUR** requires immediate attention.

1. **DO NOTHING** that could ignite the gas. **DO NOT** operate any electrical switches. **DO NOT** unplug any power supply or extension cables. **DO NOT** light matches or cause any other source of flame or spark. **DO NOT** use your phone.
2. Get everyone out of the building and away from the area immediately.
3. Close all propane (LP) gas bottle fuel supply valves.
4. Propane (LP) gas is heavier than air and may settle in low areas. When you have reason to suspect a propane leak, keep out of all low areas.
5. Call your fire department. **DO NOT** re-enter the building or area.
6. Stay out of the building and away from the area until declared safe by the firefighters.
7. **FINALLY.** Let the firefighters check for escaped gas. Have them ventilate the building and area before you return. Properly trained service people must repair any leaks, check for further leakages and then re-light the heater for you.

### 8. IF YOU SMELL EVEN A SMALL AMOUNT OF GAS, CONTACT YOUR FIRE DEPARTMENT. DO NOT WAIT!

#### NO ODOUR DETECTED

1. Some people cannot smell the odour added to propane (LP). You must determine if you can smell the odourant in this fuel.
2. Learn to recognize the odour of propane (LP) gas. Local propane (LP) gas dealers may give you a "scratch and sniff" pamphlet. Use it to become familiar with the fuel gas odour.
3. Smoking can decrease your ability to smell. Being around an odour for a period of time can affect your sensitivity to that particular odour. Odours present in animal confinement buildings can mask fuel gas odour.

#### ODOUR FADING

1. The odourant in propane (LP) gas is colourless and the intensity of its odour can fade under some circumstances.
2. Propane (LP) gas odour may differ in intensity at different levels. Since Propane (LP) gas is heavier than air, there may be more odour at lower levels.
3. Always be sensitive to the slightest gas odour. If you continue to detect any gas odour, no matter how small, treat it as a serious leak.

---

## FEATURES OF THE GRH15-BM

---

Understanding the basic operation of the heater will reinforce the need to maintain it in top condition at all times whilst always observing the safety precautions.

The heater comprises of three basic systems:

1. The gas system.
2. The ignition system.
3. The safety control system.

### **GAS SYSTEM**

The gas supply to the heater is by means of a high pressure hose, connected to a LPG bottle via a pressure regulator. When the gas shut off valve is opened, gas will flow to the control valve and finally into the burner.

This heater is designed for use with **PROPANE GAS ONLY**. Gas bottles are readily available from builders merchants or gas suppliers etc.

This heater is designed to operate with a minimum 20 pound (9 kg) propane bottle. Note that less gas is vaporised at lower temperatures. Your local propane gas dealer will help you select the proper gas supplies.

### **IGNITION SYSTEM**

A Piezo-electric igniter is positioned at the burner head. When the igniter button is depressed a high intensity spark is generated which ignites the gas. Heat from the flame is sensed by a thermocoupler connected to the control valve. As the thermocoupler heats up, the control valve opens so that after a short period, the control valve plunger (see Operation page 10) may be released and the gas flame is established.

### **SAFETY CONTROL SYSTEM**

Should the flame extinguish for any reason the thermocouple will quickly cool, causing the control valve to close, shutting off the gas supply.

Additionally, the heater is fitted with a 'Tip Over Switch' which operates should the heater be tilted by more than 35-40 degrees, thereby shutting off the gas supply.

---

# INSTALLATION

---

## UNPACKING

Remove the heater from the carton and remove all protective material used for shipment. Check the heater for possible shipping damage. Should any damage be apparent, please notify your CLARKE dealer immediately.

## BOTTLE MOUNTING

1. Place the support bracket over the rim of the gas bottle and tighten the handle bolt.

**NOTE:** Always place the heater pointing outwards from the rim of the gas bottle.

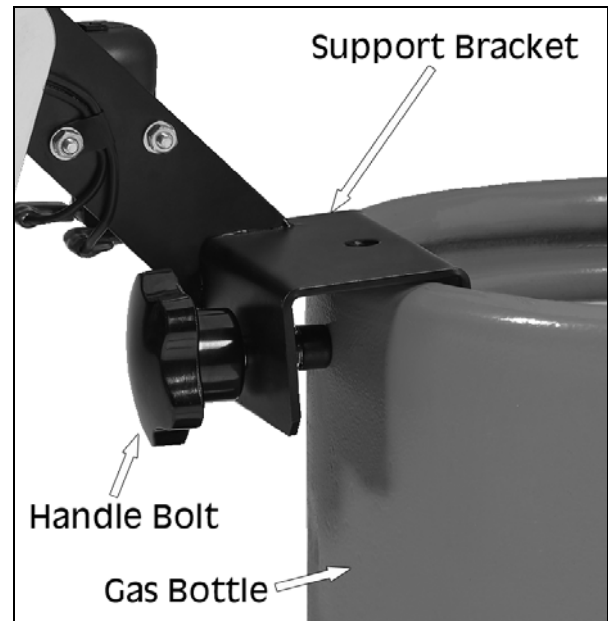

## LOCATING THE HEATER

Although a 'tip-over' switch is fitted, the propane gas bottle must be located on a hard, level surface to minimize the risk of accidental tipping. The propane gas bottle should be adequately restrained if needed. **Only operate this heater with the supply bottle in the upright position.**

This heater must only be used in locations where the potential for damage to the heater or personal injury (burns), is reduced to a minimum.

The heater must be located where it will not be exposed directly to rain and/or dripping water.

Use of this heater in a drafty area reduces its efficiency. Wherever possible, operate in a draft free area.

The heater must always be directed away from the propane gas bottle.

Position the heater at a safe distance of 1 metre from combustible materials.

The heater must not be used on floors covered in combustible materials.

---

# GAS CONNECTION

---



**WARNING: PROPANE GAS BOTTLES MUST BE USED AND STORED IN ACCORDANCE WITH THE 'HIGHLY FLAMMABLE LIQUIDS AND LIQUEFIED PETROLEUM GASES REGULATIONS 1972.**

**WARNING: IF YOU DO NOT FOLLOW THESE INSTRUCTIONS EXACTLY, A FIRE OR EXPLOSION MAY RESULT CAUSING PROPERTY DAMAGE, PERSONAL INJURY OR LOSS OF LIFE.**

---

The hose for connecting the heater to the gas bottle is supplied loose and must be fitted by the user.

Make the connection to the propane bottle in a well ventilated area using the regulator and hose assembly supplied.

1. Attach the hose to the inlet connection and tighten using a 9/16 spanner.
2. Remove the protective plug by unscrewing clockwise.

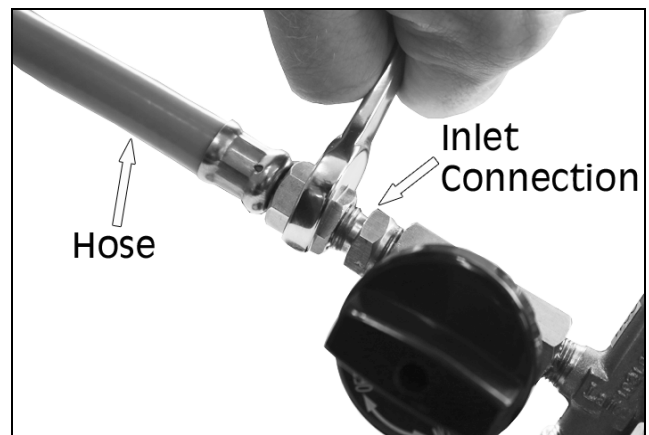

3. Attach the regulator to the gas bottle ensuring the bottle connection is perfectly clean. Blow out with compressed air if necessary to blast away any dust or dirt. (Use eye protection when working with compressed air).





4. Check the bullnose connection on the regulator for any visible damage before connecting to the bottle.

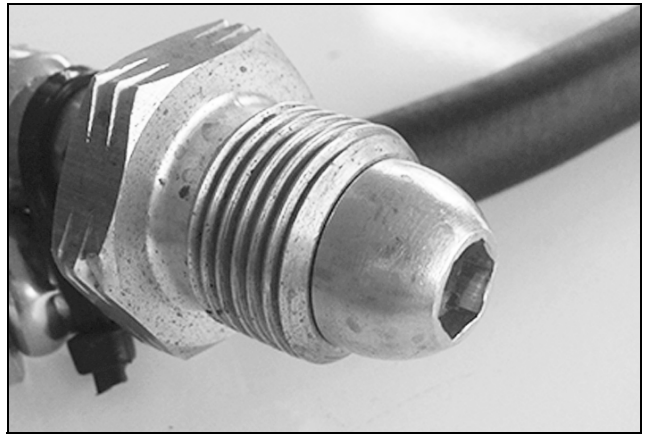

5. Place the regulator on the bottle connection and hand tighten by turning anti-clockwise.



6. Tighten firmly using a gas spanner (or an adjustable spanner), continuing in an anti-clockwise direction.



7. Simply turn the valve hand wheel anti-clockwise when you need to start the flow of gas. Ensure that you turn the bottle off when not in use.
8. In order to reduce the risk of icing up when operating for long periods at maximum capacity, you should use a larger capacity gas bottle.
9. Open the bottle gas valve and check all gas connections with a soap and water solution **ONLY. NEVER USE A FLAME.**
10. Use a full bottle wherever possible with good air circulation and no frost on the bottles.

---

## OPERATION

---



**WARNING: BEFORE STARTING THE HEATER YOU MUST ENSURE THAT THE MINIMUM VENTILATION REQUIREMENTS ARE OBSERVED TO AVOID THE RISK OF CARBON MONOXIDE POISONING.**

**WARNING: THIS HEATER WILL BE HOT DURING NORMAL OPERATION. AVOID PHYSICAL CONTACT. DO NOT ALLOW CLOTHING OR OTHER COMBUSTIBLE MATERIALS TO TOUCH THE HEATER.**

---

### FIRST USE

Read these instructions carefully. **DO NOT** allow anyone who has not read the instructions to light, adjust, or operate this heater.

**DO NOT** attempt to operate the heater with any fuel other than LPG (liquid propane gas).

The heater reaches a very high temperature and during first use you may notice an odour coming from the heater. This is quite normal and will disperse quickly.

(It is suggested the heater is initially run outdoors on the first occasion to enable the odour to clear).

Set the burner at the required angle to project the heat forward and away from the gas bottle.

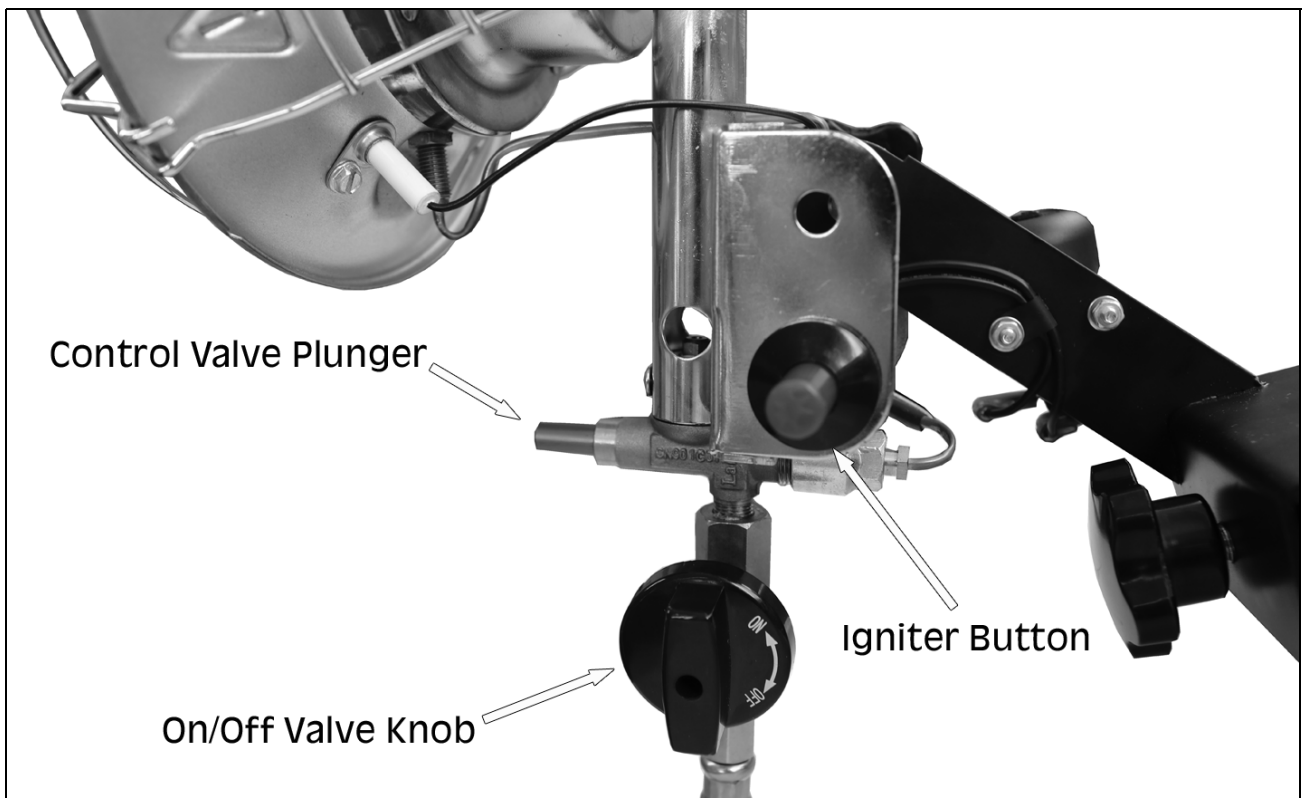

## LIGHTING THE HEATER

1. Ensure that the gas is correctly connected and leak free. Turn on the gas supply at the bottle and at the shut off valve (marked ON/OFF on the knob).
2. Press and hold the control valve plunger whilst repeatedly pressing the piezo-electric igniter button until the burner ignites.
  - Once the burner ignites, keep the control valve plunger depressed for 12-15 seconds or until the burner stays lit after it is released.



**WARNING: DO NOT FACE THE HEATER ELEMENT WHEN STARTING - ALWAYS STAND TO ONE SIDE.**

---

**NOTE:** If a new gas bottle has been connected, it may take time for the gas line to be purged of air. Press the Piezo electric ignition button every 10-15 seconds until it ignites.

3. Alternatively, hold a lit taper to the burner face while pressing and holding the control valve button. After the burner ignites, keep the button pressed for 12-15 seconds or until the burner stays lit after releasing the button.

**NOTE:** It may be necessary to bleed trapped air out of the supply line before lighting. Open the shut off valve and listen for the gas passing through the heater for a few moments before operating the igniter and attempting to light the heater. New installations generally require this.

**NOTE:** When lighting the burner with a taper, light at the bottom of the screen, not at the nozzle.

## SHUTTING OFF THE HEATER

1. Close the propane gas supply bottle valve.
2. Observe the burner until the flame is extinguished.
3. Close the shut off valve on the heater.
4. DO NOT re-open the propane gas supply bottle valve before the shut-off valve is closed.

# TROUBLESHOOTING

Fault	Cause	Remedy
Burner fails to light	<ol style="list-style-type: none"> <li>1. Gas supply valve closed.</li> <li>2. Excess gas flow</li> <li>3. Piezo ignition not sparking.</li> <li>4. Defective thermocouple</li> </ol>	<ol style="list-style-type: none"> <li>1. Open gas supply valve slowly</li> <li>2. Close propane supply valve at propane bottle and re-open slowly.</li> <li>3. Check wire lead for damage. Replace igniter assembly. Do not bend the electrode as this may cause breakage.</li> <li>4. Replace thermocouple</li> </ol>
No gas flow to the burner.	<ol style="list-style-type: none"> <li>1. Bottle gas valve closed.</li> <li>2. Bottle is empty.</li> <li>3. Nozzle is obstructed.</li> <li>4. Gas leaks from the supply hose or from tap.</li> <li>5. Low gas pressure.</li> <li>6. Control valve needs to be replaced.</li> <li>7. Loose wire on tip over switch.</li> <li>8. Loose or broken wire.</li> <li>9. Loose/mis-located thermocouple.</li> <li>10. Defective thermo-couple.</li> <li>11. Defective control valve</li> </ol>	<ol style="list-style-type: none"> <li>1. Open the gas valve slowly</li> <li>2. Replace bottle.</li> <li>3. Remove &amp; clean the nozzle.</li> <li>4. Use soapy water to find the leak and repair.</li> <li>5. Check for proper gas supply.</li> <li>6. Replace control valve.</li> <li>7. Tighten wires on switch.</li> <li>8. Tighten or repair wire.</li> <li>9. Tighten thermocouple. Make sure that thermocouple is located correctly.</li> <li>10. Replace thermocouple.</li> <li>11. Replace the control valve.</li> </ol>
Heater stops during operation.	<ol style="list-style-type: none"> <li>1. Excessive gas supply.</li> <li>2. Insufficient gas supply due to ice formation on the bottle.</li> <li>3. The tip-over switch has tripped.</li> </ol>	<ol style="list-style-type: none"> <li>1. Check the pressure regulator and replace if necessary.</li> <li>2. Check &amp; use a larger bottle, or two or more in parallel.</li> <li>3. Heater has fallen over. Right it. Take steps to prevent re-occurrence.</li> </ol>

---

## CLEANING & MAINTENANCE

---



**WARNING: NEVER ATTEMPT ANY MAINTENANCE WHILE IT IS CONNECTED TO THE PROPANE SUPPLY, IS OPERATING, OR IS HOT. (SEVERE BURNS CAN RESULT).**

---

1. Turn the heater off and let it cool for at least 15 minutes before cleaning.
  2. Inspect the heater before each use. Check the connections for leaks. Apply a mixture of liquid soap and water to the connections. Bubbles forming indicate a leak. Correct any leaks at once.
  3. Keep the heater clean. Clean the heater annually or as needed to remove dust and debris. If the heater is dirty or dusty, clean with a damp cloth. Use household cleaners on difficult spots. To clean the reflector, unclip the guard from the front of the heater.
  4. Clean the inside of the heater using compressed air where possible. Blow air across the burner face until all dust has been dislodged from the surface (Always wear eye protection when using compressed air).
  5. If the hose shows evidence of excessive abrasion or wear or if the hose is cut it must be replaced prior to the heater being put into operation. The replacement hose assembly shall be as supplied by CLARKE International.
  6. The heater, including hose and regulator assembly, must be inspected at least annually by a qualified service person.
- 

## SPECIFICATIONS

---

Gas Type	LPG (Propane)
Output	4.7 kW (15,000 BTU/Hr)
Regulator Pressure	700 mbar (propane)
Inlet pressure	1-16 bar
Regulator flow rate	2 kg/hr
Fuel Consumption	0.34 kg/hr
Gas Hose Length	800 mm
Weight unpacked	2.1 kg
Dimensions (W x D x H)	210 x 260 x 340 mm
Ignition System	Piezo

# COMPONENT PARTS

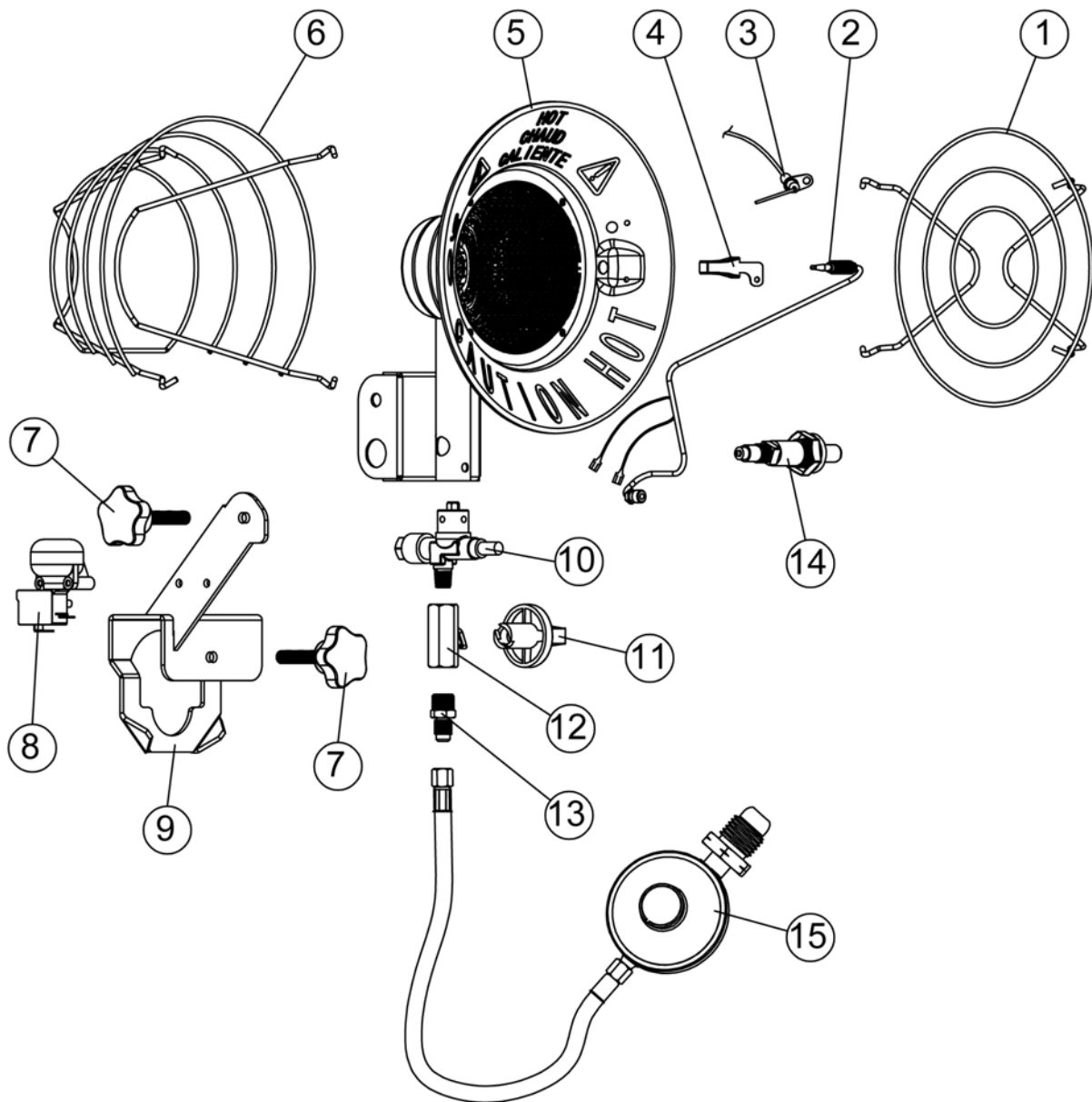

1	Front Guard Assembly
2	Thermocouple
3	Igniter Electrode
4	Thermocouple Protection
5	Burner Assembly
6	Rear Guard Assembly
7	Handle Bolt
8	Tip-Over Switch

9	Support Bracket
10	Gas Valve
11	On/Off Valve Knob
12	On/Off Valve
13	Inlet Connector
14	Piezo Igniter
15	Hose/Regulator Assembly

# DECLARATION OF CONFORMITY

**UKCA**

**Clarke**  
INTERNATIONAL  
Hennell Street, Epping, Essex, CM16 4LG

**DECLARATION OF CONFORMITY**

This is an important document and should be retained.

We hereby declare that this product(s) complies with the following legislation:  
*The Gas Appliances (Enforcement) and Miscellaneous Amendments Regulations 2018*

The following standards have been applied to the product(s):  
EN 16129:2013, EN 16436-1:2014+A3:2020

The technical documentation required to demonstrate that the product(s) meet(s) the requirement(s) of the aforementioned legislation has been compiled and is available for inspection by the relevant enforcement authorities.

The UKCA mark was first applied in: 2023

Product Description: Infrared Gas Heater  
Model Number(s): GRH15-BM  
Serial/Batch Number: Refer to product/packaging label  
Date of Issue: 21/02/2023

Signed:   
J.A Clarke  
Director

GRH15-BM UKCA Clarke DOC 022123

Page 1 of 1

**CE**

**Clarke**  
INTERNATIONAL  
Fitzwilliam Hall, Fitzwilliam Place, Dublin 2

**DECLARATION OF CONFORMITY**

This is an important document and should be retained.

We hereby declare that this product(s) complies with the following legislation:  
*2016/426 Gas Appliance Regulation*

The following standards have been applied to the product(s):  
EN 16129:2013, EN 16436-1:2014+A3:2020

The technical documentation required to demonstrate that the product(s) meet(s) the requirement(s) of the aforementioned legislation has been compiled and is available for inspection by the relevant enforcement authorities.

The CE mark was first applied in: 2023

Product Description: Infrared Gas Heater  
Model Number(s): GRH15-BM  
Serial/Batch Number: Refer to product/packaging label  
Date of Issue: 21/02/2023

Signed:   
J.A Clarke  
Director

GRH15-BM CE Clarke DOC 022123

Page 1 of 1

# A SELECTION FROM THE VAST RANGE OF

# Clarke®

## QUALITY PRODUCTS



**AIR COMPRESSORS**  
From DIY to industrial, Plus air tools, spray guns and accessories.

**GENERATORS**  
Prime duty or emergency standby for business, home and leisure.

**POWER WASHERS**  
Hot and cold, electric and engine driven - we have what you need

**WELDERS**  
Mig, Arc, Tig and Spot. From DIY to auto/industrial.

**METALWORKING**  
Drills, grinders and saws for DIY and professional use.

**WOODWORKING**  
Saws, sanders, lathes, mortisers and dust extraction.

**HYDRAULICS**  
Cranes, body repair kits, transmission jacks for all types of workshop use.

**WATER PUMPS**  
Submersible, electric and engine driven for DIY, agriculture and industry.

**POWERTOOLS**  
Angle grinders, cordless drill sets, saws and sanders.

**STARTERS/CHARGERS**  
All sizes for car and commercial use.



## PARTS & SERVICE: 0208 988 7400

**Parts Enquiries**  
[Parts@clarkeinternational.com](mailto:Parts@clarkeinternational.com)

**Servicing & Technical Enquiries**  
[Service@clarkeinternational.com](mailto:Service@clarkeinternational.com)

SALES: UK 01992 565333 or Export 00 44 (0)1992 565335

**Clarke® INTERNATIONAL** Hemnall Street, Epping, Essex CM16 4LG  
[www.clarkeinternational.com](http://www.clarkeinternational.com)